

PLAN 1 ETG.

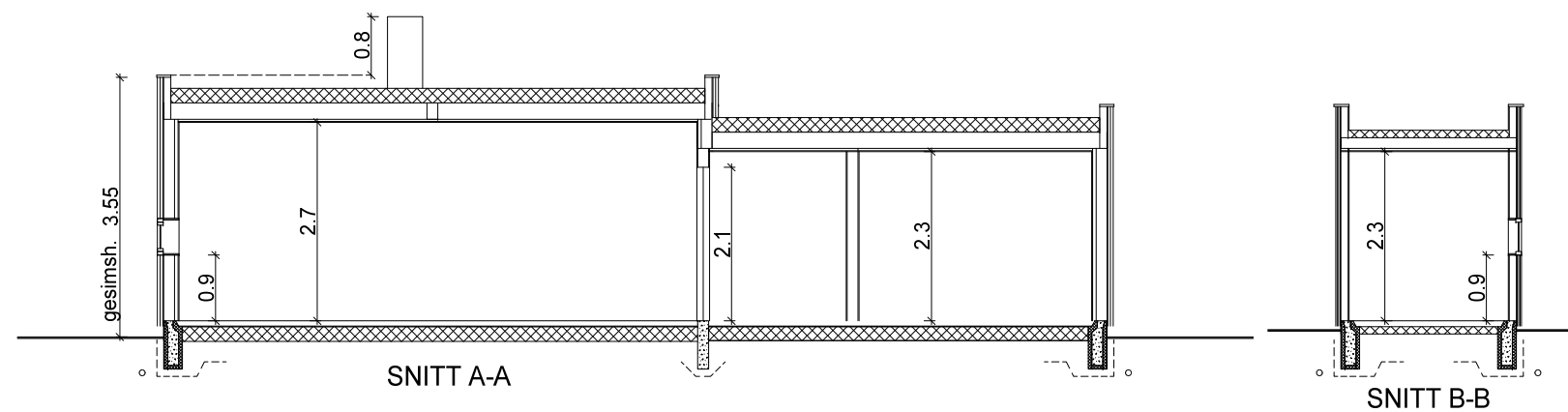

# VISTE

A Rev

01.07.2017 Vvl

Arealberegninger i hht. NS 3940	Bruksareal BRA i m <sup>2</sup>		
	Pr etasje	Utvendig bod/garasje	Sum BRA
<b>H. etg. plan</b>	65.7	7.4	73.1
<b>SUM :</b>	65.7	7.4	73.1
<b>BYA :</b>	89.8	9.5	99.3
Grunnflate/ fotavtrykk :	83.7 inkl. bod		

Tiltakshaver:	Målestokk <b>1:100</b>	Tegn IG	Dato 16.09.2016
Byggeplass :		Trac	Dato
Kommune :	Gnr Bnr	Disk Viste	Sak
		Tegn nr	Vist1501
		Prosj nr	

© Tegningen er beskyttet iht lov om opphavsrett

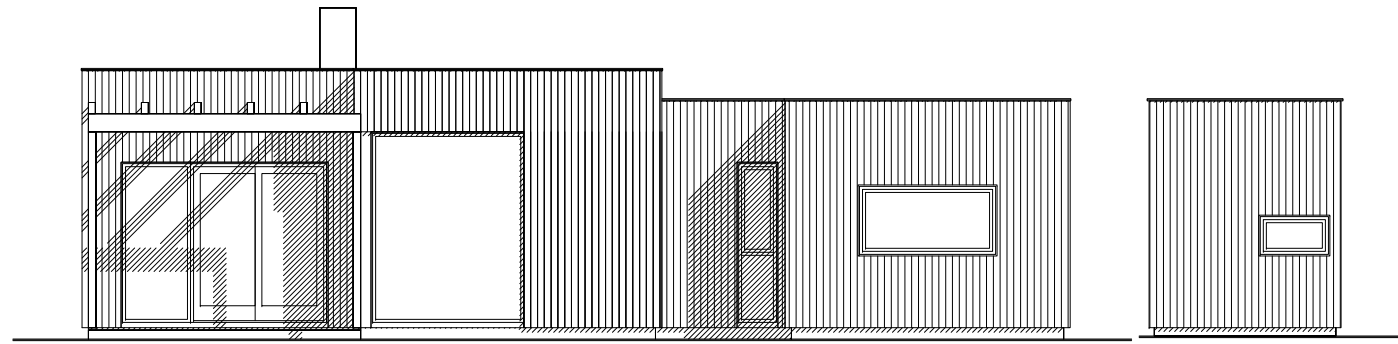

FASADE MOT

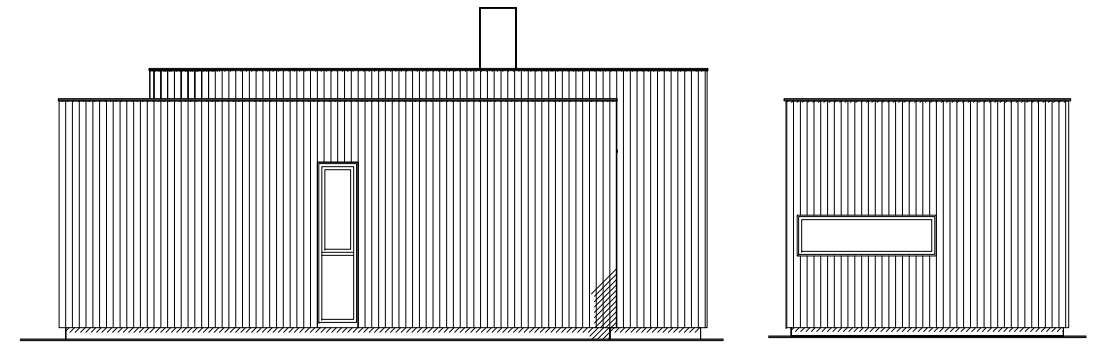

FASADE MOT

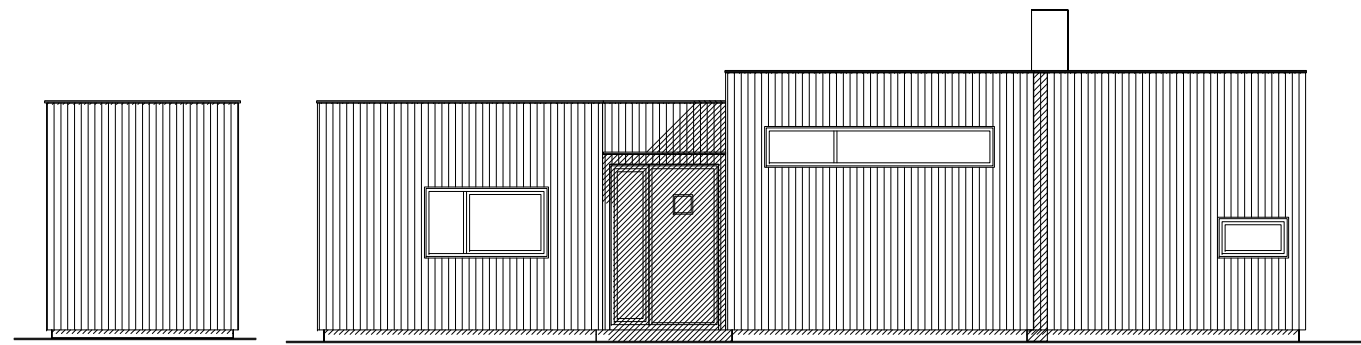

FASADE MOT

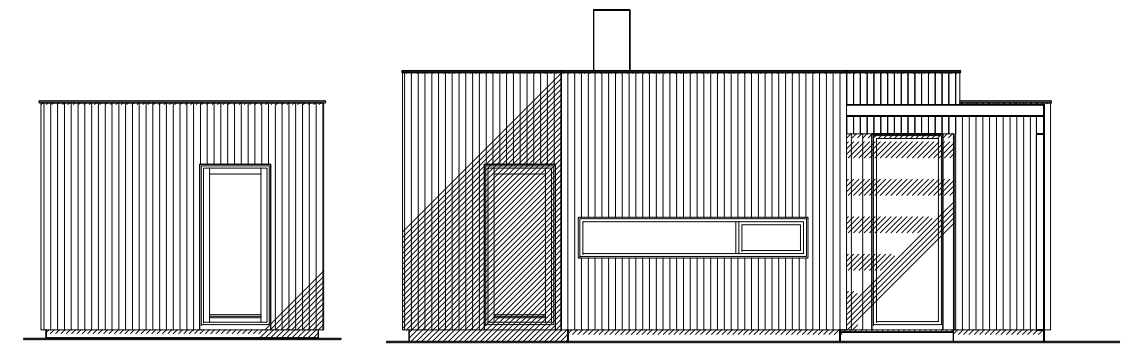



FASADE MOT

# VISTE

A Rev

01.07.2017 Vvl

Tiltakshaver:	Målestokk 1:100	Tegn IG	Dato 16.09.2016
Byggeplass :		Trac	Dato
Kommune :	Gnr Bnr	Disk Viste	Sak
 		Tegn nr	Vist1502
		Prosj nr	